

Sikaflex® Marine Handbook



Bonding and Sealing Systems

High-tech, High bond.

When the marine industry specifies a product, durability is high on its list of requirements. And for the boat owner, durability is an essential prerequisite for the smooth running of the vessel, the untroubled enjoyment of passengers and the sheer joy of sailing. Whether at the wheel of a power boat or at the tiller of a sailing yacht: there's nothing quite like that feeling of freedom when you're out there on your own, facing the elements ... or that feeling of total tranquillity with only the horizon ahead and blue skies above. Times like this make your boat a possession to cherish, and a valuable asset that you'll want to protect against the elements for many years to come.

Water leaks, in particular, can damage your prized possession, leaving unsightly marks along the hull and causing woodwork to rot and metal components to corrode. To avoid expensive repair bills, watertight seals are absolutely essential.

Deck caulking

For timber decks that are completely watertight and weather resistant, Sika has developed Sikaflex®-290 DC. Extremely easy to use, this one-part polyurethane deck caulking compound can be sanded flush with the deck when cured to give a beautifully neat, clean finish.

Sealing

Resistant to weathering, seawater and ultra-violet radiation, Sikaflex®-291 is the perfect all-rounder: an all-purpose flexible marine sealant that bonds extremely well to all the standard materials used in boat construction. Its outstanding elasticity ensures a durable, long-lasting seal.

Bonding

Joints that are subject to extreme dynamic stresses require a high-strength elastic adhesive with good gap-filling capabilities. Sikaflex®-292, with its excellent shock-absorbing and vibration-damping properties, has been specially developed to meet these requirements in the punishing marine environment. When your safety may depend on it, only the best is good enough.

Bonding of plastic glazing panels

This is an application that calls for a UV-resistant adhesive with a high degree of elasticity. Sikaflex®-295 UV combines the necessary elasticity with exactly the right consistency to maintain the required bond line thickness, thus ensuring that thermal movements in plastic glazing panels are absorbed progressively, without undue build-up of stresses.

Bonding and sealing of mineral glass

Direct glazing of mineral glass requires a purpose designed adhesive with the right combination of application properties and performance characteristics. Sikaflex®-296 is a fast curing high performance elastic polyurethane that is suitable for all types of mineral glass. It's high UV resistance also makes it suitable for backfilling and sealing operations.

Bedding and bonding of panels and sheet materials.

Sikaflex®-298 is a viscous, full-bodied adhesive that has been specially formulated for the waterproof, flexible bonding of timber strip decking, deck planking, plastic deck coverings and prefabricated timber deck panels. It is easy to work with, and gives professional results every time. The permanently elastic adhesive layer has a cushioning effect absorbing shocks and minimizing the transmission of impact sound.

Different products Same benefits.

Sika pioneered the development of one-component polyurethanes for marine use. Our global technical resources have enabled us to produce a wide range of products, each aimed at a specific marine application. Although the individual product characteristics vary, they all share the following features:

- One component - no mixing necessary
- Excellent gap-filling capabilities
- Permanently elastic
- Can be sanded and overpainted
- Excellent non-sag properties
- High solids content, low V.O.C.
- Non-corrosive
- For use above or below the waterline
- All are specifically designed for marine use.



Contents

Introduction.....	2
Bonding and Sealing basics.....	3
Working with teak.....	4
Instructions for	
<i>Bonding and Caulking Teak Decks</i>	5-7
<i>Bonding of Deck Panels and Feature Decks</i>	8
<i>Bonding Anti-Slip Deck Coverings</i>	9
<i>Bonding of Anti-Slip Plates for Engine Rooms</i>	10
<i>Bonding Timber Components</i>	11
<i>Bedding and Sealing of Fittings and Hardware</i>	12
<i>Sealing of High-UV-Risk Areas</i>	13
<i>Bonding of Rub Rails and Fenders</i>	14
<i>Keel-to-Hull Joints and Sealing</i>	15
<i>Bonding and Sealing Organic “Glass” (Plastic) Windows</i>	16/17
<i>Bonding and Sealing Mineral Glass Windows</i>	18/19
<i>Bonding of Decorative Panels and Work Surfaces</i>	20
<i>Notes on Substrates</i>	21/22
<i>Sika Marine Products Technical Data</i>	23
<i>Cleaner, Primer and Adhesive Consumption Table</i>	24
Primer Chart for Sika Marine Application.....	25/26

Sikaflex® in Boat Construction and Maintenance.



Since the middle of the 17th century, when the industrial revolution started, to the present day, the process of joining has changed dramatically.

Nowadays the most advanced technology in marine is based on elastic adhesives.

Historically no technique in ship building has evolved as strongly over the centuries as the technology of deck caulking. In the early days, woollen or cotton caulking yarn, in combination with bituminous materials, were employed. Nowadays the use of elastomeric materials are common worldwide, especially as these elastic sealants not only fill the joint but additionally seal and bond similar and dissimilar substrates simultaneously.

The task of elastic bonding is to join, to waterproof, to dampen sound, to insulate and to prevent galvanic corrosion. These are all properties strongly associated with the marine environment, particularly in the manufacture and repair of ships, boats and yachts.

Sikaflex® elastic bonding/sealing systems allow for:

- Joining of similar and dissimilar materials
- Wider production tolerances

- Prevention of galvanic metal corrosion
- Compensation for variable rates of thermal expansion
- Noise and vibration dampening
- Elimination of localised stresses
- High shear and peel strengths
- Freedom of design
- Savings on custom-made seals and gaskets
- Simultaneous assembly and sealing operation
- Overpaintability
- High resistance to tear
- Simple one-component, humidity-curing system
- Prevention of deformation of metals due to thermal joining processes (welding, etc.)
- Two-component and fast-curing versions for high initial strength and fast handling
- Weight- and cost-saving options
- Availability in all consistencies from fluid to non-sag
- Prevention of damage to the substrate, unlike with welding, drilling or riveting systems
- Joining of painted components
- High durability for a long service life
- High resistance to UV radiation
- Proven resistance to seawater and extreme climate conditions
- Distortion-free joining
- Flexible manufacturing procedures
- High-impact resistance

No single adhesive will meet all requirements and few surfaces are completely ideal for bonding, hence Sika manufacture a comprehensive range of adhesive and primer systems specifically for marine applications.

If your requirement is not covered in this handbook or you need details of a local supplier, please contact Sika for further advice.



Bonding and Sealing Basics

Sika's adhesives and sealants are working materials which show good affinity for other surfaces. Their task is to flow as a liquid onto and into the contours of a surface and then transform themselves into a solid, by developing both a physical and a chemical bond with the substrate. Sika Marine Adhesive and Sealant Systems can range from fluid liquids to heavy thixotropic paste-like systems, able to supply low-to-high-strength values and cure to a highly elastic or rigid bond. The ability of the adhesive or sealant to "wet" a surface is very critical in the development of a proper bond; solidification (curing) can take place through a physical or a chemical reaction or through both at the same time. Experience has shown that chemically reactive adhesives like Sikaflex® have the highest strength, durability and resistance to water.

Preparation

Correct surface preparation is key to successful bonding.

Where there are weak or contaminated surfaces, extensive preparation maybe needed to ensure a perfect bond. Typical problems are dust, dirt, grease, oil, rust, flaking paint, etc.

The preparation selected will depend on the type of substrate (metal, plastic, paint, wood, etc.), the operating conditions in service, the

degree of surface deterioration and the practicalities of any particular installation. See the 'notes on substrates' in this manual or contact Sika for details.

Mechanical Cleaning

Mechanical preparation, will be required if, for example, corrosion is apparent, weak surface layers prevail, or surface degradation is showing. The level of cleaning will be determined by the type of surface and the degree of deterioration. Preparation techniques include the use of abrasive nylon pads, abrasive paper/fabric, wire brushing, abrasive wheels, and wet or dry grit blasting. Following mechanical treatment, additional cleaning with solvents may also be required.

Dedusting, Degreasing

If compressed air is used to remove dust from surfaces, the air should be filtered to remove traces of oil.

The use of vacuum cleaners is even better for dust removal. All nonporous surfaces must be cleaned prior to Sikaflex® application.

Only Sika-recommended cleaning materials should be used. Solvents, such as White Spirits and alcohol based, are not recommended as they can hinder cure or subsequent adhesion. Always use clean, lintfree wipes, and change them frequently to ensure that the contamination is removed from and not redistributed onto the surface.

Once clean, the substrates should

be left to completely dry before proceeding to the next operation.

Note: Certain solvents, including Sika Cleaner®-205, are not recommended for use on absorbent substrates as unevaporated solvents can affect the curing mechanism of Sikaflex®.

Priming

Priming is a means of transforming a surface, either chemically, physically or both, into an ideal condition for successful bonding, thus ensuring long-term performance. The simplest form of priming is wiping the prepared surface with a conditioner (such as Sika Activator®) which reacts with the surface providing improved "wetting" characteristics and more reactive sites.

Porous and rough surfaces require a primer with "film-forming" properties to re-profile the surface, producing a denser, more even bond line.

Primers must always be allowed to dry thoroughly before application of the Sikaflex® adhesive. If left too long, primed areas must be reapplied or reactivated. Minimum and maximum drying times are given in the primer chart in this guide. Primed surfaces should be protected from contamination by dust, dirt, grease, vapours, moisture, etc., until the bond is formed.

Working with Teak

Teak has been used for hundreds of years as a decking material for ships and boats because of its anti-rot properties. Teak is a beautiful material in its unfinished state and, when caulked with Sikaflex®, provides an elegant solution for the anti-slip properties required from a wet deck.

Teak, however, is not a uniform material; oil, and resin-content, as well as porosity, vary greatly and the water content changes depending on storage conditions, duration, temperature and humidity.

General Conditions

Proper working conditions are essential for a successful result.

- Optimal results are obtained under constant or falling temperature conditions of between +5°C and +25°C.
- Exposure to direct sunlight and rain during the operation and especially during bonding or caulking needs to be avoided under all circumstances.
- Exposure to the elements during and following each step of the application procedure needs to be prevented for at least 8 hours.
- Good ventilation in a well-organised working area are important factors for success.

The Quality of the Wood

- Teak planks should show vertical, standing year rings.
- The core humidity content of the wood should ideally not exceed 12%. Too high a level could result in excessive shrinkage leading to failure.

Ideally, the humidity content of the timber should correspond to the equivalent humidity expected in service.

Teak Decks

It is imperative that the width of the seams be directly related to the width of the teak planks and to the depth of the seam; guidelines are listed below.

Should the joint dimensions not conform with our recommendations, please contact Sika.



plank width		seam width		seam depth	
(mm)	(in)	(mm)	(in)	(mm)	(in)
35	1 ³ / ₈	4	⁵ / ₃₂	4 to 5	⁵ / ₃₂ – ³ / ₁₆
45	1 ³ / ₄	4 to 5	⁵ / ₃₂ – ³ / ₁₆	6	¹ / ₄
50	2	5 to 6	³ / ₁₆ – ¹ / ₄	6	¹ / ₄
75	3	8	⁵ / ₁₆	7	⁹ / ₃₂
100	4	10	¹³ / ₃₂	8	⁵ / ₁₆
125	5	12	¹⁵ / ₃₂	10	¹³ / ₃₂

Instructions for Bonding Teak Decks



Preparation of Substrate

Glassfibre Reinforced Plastic (GRP) Decks



Heavily soiled surfaces should be cleaned off first with a pure solvent (Sika® Remover-208) to remove the worst of the soiling.



Lightly abrade contact area with a very fine sanding pad. Remove dust with a vacuum cleaner.



Clean the substrate with Sika® Cleaner-205, using a clean, lint-free rag or paper towel. Change frequently!



Drying time: minimum 10 minutes, maximum 2 hours



Apply a thin, continuous coat of Sika® Primer-206 G+P or Sika® Primer-215, using a clean brush or felt applicator.



Drying time: minimum 30 minutes, maximum 24 hours

Timber Decks



Abrade contact area on hull with sanding pad (80/100 grit) and remove dust with a vacuum cleaner.



Apply a thin, continuous coat of Sika® Primer-290 DC, using a clean brush or felt applicator.



Drying time: minimum 60 minutes, maximum 24 hours

Aluminium and Steel Decks



If the deck is already coated with a primer but adhesion cannot be assured or the primer is soluble in Colma Cleaner, the primer must be removed by gritblasting.



If adhesion can be assured, the surface should be cleaned with an appropriate aqueous cleaner and subsequently washed.



Apply a continuous coat of two-component Sika Icosit® EG 1 to the surface using a clean brush or roller at a consumption of 200 g/m².



Drying time:
10°C 48 h–14 days
20°C 24 h–14 days
30°C 14 h–14 days

Application of Sikaflex®-298 Adhesive/Bedding Compound

Sikaflex® 298 will accommodate minor variations in deck levels.

If prelevelling is required, contact Sika for details of the SikaTransfloor® 352 lightweight deck levelling compound



Apply Sikaflex®-298 to the previously prepared surface and spread over the area to be covered, using a spreader with 5 mm x 5 mm square notches at a quantity of up to 600 g/m². The exact quantity, however, depends on the regularity of the surface; care should be taken that a continuous film of Sikaflex®-298 is applied to avoid the potential risk of water penetration through the teak deck. (Figs. A, B)



The bond face of the teak planks is de-oiled and primed as for deck caulking (see page 6). The teak planks must be positioned accurately within 20 minutes of applying the adhesive and pressed firmly into place. It is therefore recommended that only a limited surface area be applied that can be covered with teak within the time available. (Fig. C)



To fix and ensure the planks are embedded without voids, clamps, weights or screws (removable once the adhesive has set) must be used to secure the panel while the adhesive sets. Alternatively, the vacuum press method may be used. After approx. 24 hours the panels can carry their full service load and the temporary fastenings can be removed.



Traces of uncured Sika adhesives or sealants may be removed with Sika® Remover-208. On no account should other cleaning agents or Sika® Cleaner-205 be used for this purpose.

Important: Please refer to the current Sika Technical Data Sheets and Safety Data Sheets obtainable through Sika or their local distributor.



Fig. A



Fig. B



Fig. C

Instructions for Caulking Teak Decks



Before caulking the deck, ensure the seam width and depth meets the guidelines listed on page 4.

Preparation of Substrate Seams



When recaulking older decks, existing caulking should be removed and the seams routed out to the required dimensions.



In order to achieve long-term adhesion of Sikaflex®-290 DC to the sides of the seams, a meticulous preparation of the sides is required. All foreign material must be removed and the seams must be clean and dry prior to the application of the primer. Best results are obtained using a high-powered industrial vacuum cleaner. Pneumatic equipment should not be used unless equipped with an oil separator as teak readily absorbs oil. De-oiling of the sides is recommended and is performed using a lint-free cloth wetted with acetone or MEK (Methyl Ethyl Ketone). The cloth must be replaced at regular intervals to avoid re-soiling of the surfaces. Allow 10 minutes to flash off. Remember these solvents are flammable, so take proper precautions!

Priming

Priming the planks is a vital step in the process of caulking with Sikaflex®-290 DC. Failure to observe the priming procedure might be detrimental to the final quality of the seal and will impair the longevity of the deck. Priming may commence after thorough cleaning and de-oiling of the planks.



Fig. A Apply a thin, continuous coat of Sika® Primer-290 DC to the seam edges. Sika® Primer-290 DC can be brush or spray applied in one coat to the seam sides. To ensure that no areas are missed, move the brush back and forth. Sika® Primer-290 DC is a film former: The coating should therefore look glossy, giving a “wet-look” even when dry (Fig. A). Working temperature 5–35°C, RH: 75% max.



Drying time: Protect the primed area against dust and rain, and leave the primer to dry for at least one hour before starting the deck caulking operation. The maximum allowable time between priming and caulking is no more than 24 hours. If this period is exceeded, repriming is required.

Application of the Bond Breaker Tape



Sikaflex®-290 DC caulking compound is designed to absorb the lateral movements of the teak planks as they expand and contract with changes in the weather, the environment or due to variations in the humidity content of the teak. To ensure proper performance of the Sikaflex®, it is imperative that adhesion to the bottom of the seam section be avoided at all cost. To ensure this, a strip of release tape is applied to the bottom of the seam after the primer has dried. (Fig. B)





Fig. B

Instructions for Caulking Teak Decks





Application of Sikaflex® - 290DC

 Before any work commences ensure the temperature of the wood does not exceed 25°C. In addition, the operating temperature during application should be constant or falling and ideally within the range of +5°C and +25°C.

 Apply Sikaflex®-290 DC ensuring air is prevented from entering the seam by placing the tip of the nozzle against the bottom and keeping the gun at an angle of 60°–90°. Always use a hand gun or a piston-driven air gun. Continue to pull the nozzle along the seam so that the joint is filled behind the nozzle always ensuring a constant motion is maintained. (Figs. C,D)

 After application of Sikaflex®-290 DC and before skinning occurs, tool the excess material from the surface of the deck using a slightly flexible spatula at 45°. This ensures complete filling of the seam.

 Protect the caulked joints from rain and direct sunlight for a period of at least 8 hours. Do not use excess material from the spatula for filling seams.

 Sikaflex®-290 DC is ready for sanding after 7 days.

Important: Please refer to the current Sika Technical Data Sheets and Safety Data Sheets obtainable through Sika or their local distributor.

The Sanding Process

Following 7 days curing the deck is ready for sanding. Prior to that, however, excess cured Sikaflex®-290 DC should be removed with a sharp chisel or knife.

This procedure will avoid excess pull on the edges of the seams during the subsequent sanding operation. For effective sanding results use an industrial sander. It is recommended to begin with a medium (80) progressing to a 120 grit or finer. Suitable sanders are belt sanders, flat plate sanders or elastically suspended sanders. Sanding should be along the direction of the seams.

The Finishing Touch

Although we do not recommend the application of a finish to the exterior teak deck, many boat owners prefer to apply a lacquer finish to the deck after sanding. Generally great care should be taken as finishes contain solvents or plasticisers which can adversely affect the cured Sikaflex®-290 DC or the drying of the lacquer. The following criteria should always be taken into consideration: Never apply the lacquer finish to uncured Sikaflex®-290 DC. Waiting time of at least one month before application of the finish is recommended. The compatibility of the lacquer should be evaluated on a small sample area of the teak deck before application.

Rigid lacquers have a negative effect on the elasticity of the joint and may crack or cause loss of adhesion of the Sikaflex®-290 DC from the teak planks.

Maintenance

It is important to wet and rinse the deck regularly with fresh water in order to prevent drying out. In warm climates this procedure should be carried out on a daily basis. The occasional use of a mild detergent (natural liquid soap) diluted in water should be kept to a minimum. Bleach and aggressive chemical cleaners should not be used.

Note

Prefabricated teak decks often consist of a multilayer construction, e.g. they are made of wood onto which a fine layer of teak is bonded. The base wood might consist of various wood qualities; the pores in the “wood” are different in structure and size, therefore the caulking compound is not always in a position to expel the air pockets from the pores during caulking. As a result small bubbles within the joint may surface during caulking. To avoid the development of these “air” bubbles, we recommend tooling the joints using a smooth, slightly flexible spatula at an angle of 45°, expelling air from the pores and allowing a perfect joint to develop during cure.



Fig. C



Fig. D

Instructions for Bonding of Deck Panels and Feature Decks



Description of Application

In modern boats, timber decking is frequently constructed in the form of prefabricated panels laid over the structural deck. This method is favoured for reasons of cost.

These panels generally consist of a marine grade, WBP-bonded plywood backing with strips of teak or Oregon pine bonded or glued to the face. Alternatively, they may consist of teak planking held together by a few layers of glass fibre sheet impregnated with epoxy resin. They are available either in standard board sizes or as made-to-measure deck sections cut and machined to a template.

Another type of prefabricated panel consists of teak planking with rubber jointing strips and no plywood backing.

One-part elastic polyurethane adhesives are ideal for bonding these panels to the deck. One-part polyurethanes are resistant to sea water, they possess excellent gap filling properties, and no additional mechanical fastenings are needed. Once cured, the adhesive bond is extremely strong, permanently elastic and waterproof. Because it is waterproof and applied to the whole surface of the deck, the adhesive acts as an additional skin to protect the deck from attack by the elements. As the deck does not have to be drilled for screws or bolts, there are no holes through which water could penetrate and cause damage.

Preparation of Substrate

Glass Reinforced Plastic (GRP) Decks



Heavily soiled surfaces should be cleaned off first with a pure solvent (Sika® Remover-208) to remove the worst of the soiling.



Lightly abrade contact area with a very fine sanding pad. Remove dust with a vacuum cleaner.



Clean the substrate with Sika® Cleaner-205, using a clean, lint-free rag or paper towel. Change frequently!



Drying time: minimum 10 minutes, maximum 2 hours



Apply a thin, continuous coat of Sika® Primer-206 G+P or Sika® Primer-215, using a clean brush or felt applicator.



Drying time: minimum 30 minutes, maximum 24 hours

Timber Decks



Abrade contact area on hull with sanding pad (80/100 grit) and remove dust with a vacuum cleaner.



Apply a thin, continuous coat of Sika® Primer-290 DC, using a clean brush or felt applicator



Drying time: minimum 60 minutes, maximum 24 hours

Aluminium or Steel Decks, Coated with Two-Part Lacquer



Clean the substrate with Sika® Cleaner-205, using a clean, lint free rag or paper towel. Change frequently!



Drying time: minimum 10 minutes, maximum 2 hours

Epoxy-Backed Deck Panels



Heavily soiled surfaces should be cleaned off first with a pure solvent (Sika® Remover-208) to remove the worst of the soiling.



Lightly abrade contact area with a very fine sanding pad. Remove dust with a vacuum cleaner.



Clean the substrate with Sika® Cleaner-205, using a clean, lint-free rag or paper towel. Change frequently!



Drying time: minimum 10 minutes, maximum 2 hours



Apply a thin, continuous coat of Sika® Primer-215, using a clean brush or felt applicator.



Drying time: minimum 30 minutes, maximum 24 hours

Application of Sikaflex®-298 Adhesive



Flat surfaces: Sikaflex®-298. Inclined surfaces: Sikaflex®-291

Apply adhesive to previously prepared surface and spread over area to be covered, using a spreader with 4 mm triangular notches. The bed thickness may vary depending on the thickness of any gap that needs to be filled (normally 1–2 mm corresponding to 1-2 litres of adhesive per m²)



The deck panel must be positioned accurately within the tack free time of the adhesive and pressed firmly into place.



Clamps, weights or screws (removable once the adhesive has set) can be used to secure the panel while the adhesive sets. Alternatively, the vacuum press method may be used. After approx. 24 hours the panels can carry their full service load and the temporary fastenings can be removed.



Traces of uncured Sika adhesives or sealants may be removed with Sika® Remover-208. On no account should other cleaning agents or Sika® Cleaner-205 be used for this purpose.

Important: Please refer to the current Sika Technical Data Sheets and Safety Data Sheets obtainable through Sika or their local distributor.

- 1 Sikaflex®-290 DC
- 2 Feature deck panel
- 3 Sikaflex®-298
- 4 Deck

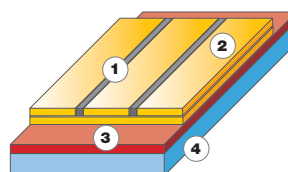

Instructions for Bonding Anti-Slip Deck Coverings



Description of Application

Deck coverings or mats of synthetic resin composition provide a safe, non-slip surface to walk on as well as protecting the deck against damage and leaks. The use of a one-part polyurethane adhesive maximises the effectiveness of the covering material, facilitates installation and ensures a professional finish.

Proprietary deck coverings in common use include:

- T B S
- Anti-slide
- Treadmaster
- Lay Tech
- Polygrip
- Nautoflex
- Norament
- Marine Deck 2000

One-part polyurethane adhesives give excellent results with these products. Installation is simple and straightforward, while the long term performance characteristics of the adhesive offer a number of significant benefits.

Preparation of Substrate and Deck Coverings

GRP Decks



Heavily soiled surfaces should be cleaned off first with a pure solvent (Sika® Remover-208) to remove the worst of the soiling.



Lightly abrade contact area with a very fine sanding pad (Scotch Brite M 600). Remove dust with a vacuum cleaner.



Clean the substrate with Sika® Cleaner-205, using a clean, lint-free rag or paper towel. Change frequently!



Drying time: minimum 10 minutes, maximum 2 hours

Timber Decks



Abrade contact area on hull with sanding pad (80/100 grit) and remove dust with a vacuum cleaner.



Apply a thin, continuous coat of Sika® Primer-290 DC, using a clean brush or felt applicator



Drying time: minimum 60 minutes, maximum 24 hours

Aluminium Decks, Coated with Two-Part Lacquer



Clean the substrate with Sika® Cleaner-205, using a clean, lint-free rag or paper towel. Change frequently!



Drying time: minimum 10 minutes, maximum 2 hours

For the preparation of other substrates, please refer to the Primer Chart.

Deck Coverings



The covering material must be free from release agents or other media used in the production process. Use MEK, Colma Cleaner, or other appropriate solvents recommended by the manufacturer. Perform a small test to verify if the substrate is affected by the solvent.



On non-porous coverings, the side that is to be bonded should be cleaned with Sika® Cleaner-205, using a clean, lint-free rag or paper towel. Change rag frequently!



Drying time: minimum 10 minutes, maximum 2 hours

In the case of covering materials with an open-pore structure or textured weave finish, the only preparation necessary is to ensure that the side to be adhered to is completely dust-free.

Note: Due to the many variations of deck coverings, a test to check for adhesion is always recommended.

Application of Sikaflex®-291/-298 Adhesive



Flat surfaces: Sikaflex®-298. Inclined surfaces: Sikaflex®-291
Apply adhesive to previously prepared surface and spread over area to be covered, using a spreader with 2 mm triangular notches. The layer thickness should be 0.5-1 mm approx.



The covering material must be placed in position within 30 minutes of applying the adhesive, so adhesive should be applied only to an area large enough to receive the next section of covering.



When the covering has been placed in position it should be rolled down with a rubber roller, working from the centre outwards to expel any trapped air and push any excess adhesive out to the edges, where it can be removed. It is essential to ensure no trapped air remains.

Note: If the covering material is laid under tension, the edges must be held or suitably weighted.



Traces of uncured Sika adhesives or sealants may be removed with Sika® Remover-208. On no account should other cleaning agents or Sika® Cleaner-205 be used for this purpose.

Important: Please refer to the current Sika Technical Data Sheets and Safety Data Sheets obtainable through Sika or their local distributor.

Instructions for Bonding of Anti-Slip Plates for Engine Rooms



Description of Application

Anti-slip plates used in technical storage rooms or in engine rooms are traditionally fixed by rivets or other mechanical fixings. Being in an area which is subjected to a lot of vibration, these soon become loose and a large amount of repair work is usually required. The use of elastic bonding technology allows a better distribution of stresses, thus avoiding the need for repair work (Fig.A). In addition, fixation and sealing of plates can be achieved in a single operation.



Fig. A

Preparation of Substrate

GRP Floor



Heavily soiled surfaces should be cleaned off first with a pure solvent (Sika® Remover-208) to remove the worst of the soiling.



Lightly abrade contact area with a very fine sanding pad. Remove dust with a vacuum cleaner.



Clean the substrate with Sika® Cleaner-205, using a clean, lint-free rag or paper towel. Change frequently!



Drying time: minimum 10 minutes, maximum 2 hours



Apply a thin, continuous coat of Sika® Primer-206 G+P or Sika® Primer-215, using a clean brush or felt applicator.



Drying time: minimum 30 minutes, maximum 24 hours

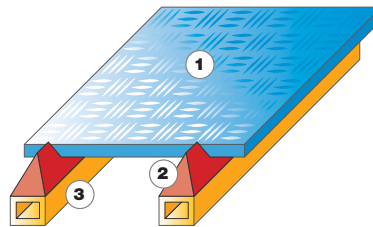

- 1 Anti-slip plate
- 2 Sikaflex®-292
- 3 Floor structure (GRP or steel)

Steel Floor



Mechanically clean the surface by grit-blasting to SA 2.5. Remove dust with a vacuum cleaner.



Clean the substrate with Sika® Remover-208, using a clean, lint-free rag or paper towel. Change frequently!



Drying time: minimum 10 minutes, maximum 2 hours



Apply a continuous coat of Sika Icosit® EG 1 (two-component, anticorrosion primer).



Drying time : minimum 14 hours, maximum 96 hours

Aluminium Anti-Slip Plate



Lightly abrade contact area with a very fine sanding pad. Remove dust with a vacuum cleaner.



Clean the substrate with Sika® Cleaner-205, using a clean, lint-free rag or paper towel. Change frequently!



Drying time: minimum 10 minutes, maximum 2 hours



Apply a thin, continuous coat of Sika® Primer-210 T, using a clean brush or felt applicator.



Drying time: minimum 30 minutes, maximum 24 hours

For the preparation of other substrates, please refer to the Primer Chart.

Application of Sikaflex®-292 Adhesive



Place spacers in position (thickness 2 mm, approximately 50 Shore A hardness). These can be pressed into the adhesive once applied.



Apply parallel rows of beads of Sikaflex®-292 in an 8 mm x 10 mm triangular profile.



Assemble components within 20 minutes of applying adhesive.



Apply pressure with weights or other fastening aids to compress adhesive to the height of the spacers.



Wait at least 24 hours before walking on the bonded plates.



Traces of uncured Sika adhesives or sealants may be removed with Sika® Remover-208. On no account should other cleaning agents or Sika® Cleaner-205 be used for this purpose.

Important: Please refer to the current Sika Technical Data Sheets and Safety Data Sheets obtainable through Sika or their local distributor.

Instructions for Bonding Timber Components



Description of Application

In yachts and pleasure craft, stairs, companion ways and handrails are frequently made from tropical hardwoods, chosen both for their durability and their attractive appearance. The use of screws to fix such items may eventually impair both their durability and their appearance, due to moisture ingress via the screw holes. For this reason, it is advisable to fix hardwood components with adhesives. The absence of screw holes prevents water from entering and damaging the timber. This is of particular importance in the construction of accommodation ladders.

In addition, bonding offers other benefits. The adhesive layer helps to absorb the sound of footsteps and cushion vibrations. The integrity of painted surfaces can be preserved without loss of corrosion protection, and the potentially harmful effects of moisture penetration into GRP are eliminated.

Preparation of Substrate

Untreated Timber (Teak, Mahogany)



Abrade contact area on hull with sanding pad (80/100 grit) and remove dust with a vacuum cleaner.



Apply a thin, continuous coat of Sika® Primer-290 DC, using a clean brush or felt applicator.



Drying time: minimum 60 minutes, maximum 24 hours

GRP



Heavily soiled surfaces should be cleaned off first with a pure solvent (Sika® Remover-208) to remove the worst of the soiling.



Lightly abrade contact area with a very fine sanding pad (80/100 grit). Remove dust with a vacuum cleaner.



Clean the substrate with Sika® Cleaner-205, using a clean, lint-free rag or paper towel. Change frequently!



Drying time: minimum 10 minutes, maximum 2 hours



Apply a thin, continuous coat of Sika® Primer-215 or Sika® Primer-206 G+P, using a clean brush or felt applicator.



Drying time: minimum 30 minutes, maximum 24 hours

Stainless Steel, e.g. Ladders



Heavily soiled surfaces should be cleaned off first with a pure solvent (Sika® Remover-208) to remove the worst of the soiling.



Lightly abrade contact area with a very fine Scotch-Brite pad. Remove dust with a vacuum cleaner.



Clean the substrates with Sika® Cleaner-205, using a clean, lint-free rag or paper towel. Change frequently!



Drying time: minimum 10 minutes, maximum 2 hours



Apply a thin, continuous coat of Sika® Primer-210 T, using a clean brush or felt applicator.



Drying time: minimum 30 minutes, maximum 24 hours

Timber, Aluminium or Steel Coated with Two-Part Lacquer



Clean the substrates with Sika® Cleaner-205, using a clean, lint-free rag or paper towel. Change frequently!



Drying time: minimum 10 minutes, maximum 2 hours

Application of Sikaflex®-292 Adhesive



Place elastic spacers in position (thickness 2 mm, approximately 50 Shore A hardness).



Apply Sikaflex®-292 to the proposed bond area using a notched spreader (4 x 4 mm) over the face of the joint.



Assemble components within 20 minutes of applying adhesive.



Apply pressure with clamps or other fastening aids to compress adhesive to the height of the spacers. Excess adhesive squeezed out around the joint should be trimmed off with a soft plastic spatula.

Note: Do not apply excessive clamping pressure. If screws are used for additional security, these should only be tightened initially to secure the components while the adhesive sets. Leave assembly for 24 hours before tightening screws.



Traces of uncured Sika adhesives or sealants may be removed with Sika® Remover-208. On no account should other cleaning agents or Sika® Cleaner-205 be used for this purpose.



Clamps and other fastening aids can be removed after 12 hours. Full service strength is attained after approximately 7 days.

Important: Please refer to the current Sika Technical Data Sheets and Safety Data Sheets obtainable through Sika or their local distributor.

For the preparation of other substrates, please refer to the Primer Chart.

Instructions for Bedding and Sealing of Fittings and Hardware



Description of Application

All kinds of deck fittings and hardware need to be securely fixed and totally watertight. Some of these fittings are also subjected, on occasion, to very high forces and torsional stresses.

Poorly sealed joints can eventually result in serious damage such as metal corrosion, osmosis and water leaks causing damage to interior furnishings and fittings.

Bedding and Sealing Fittings Subject to High Mechanical Stresses

Deck fittings such as chain plates, winches and guide rollers have to absorb very high dynamic stresses. A high-performance product, such as Sikaflex®-292, should be used in conjunction with additional mechanical fixation for this purpose.

Bedding and Sealing Fittings Subject to Minimal Mechanical Stresses

Deck fittings such as ventilators, cover strips, etc. need to be sealed against entry of water, but they are not subject to high tensile stresses. Such fittings can be effectively bedded and sealed with Sikaflex®-291.

Important Note:

It is vital to ensure that the adhesive is not simply squeezed out again when the fixing screws are

pulled up tight. To prevent this happening, shims approx. 1 mm thick should be threaded over the screws on the underside of the fitting to act as spacers. The screw holes themselves should also be filled with sealant prior to fixing.

Spacing the fitting off the deck by 2–3 mm also facilitates its removal at a later date, when a cutting wire or knife blade can be inserted between the base of the fitting and the deck.

Preparation of Substrate

Timber Decks



Abrade contact area on hull with sanding pad (80/100 grit) and remove dust with a vacuum cleaner.



Apply a thin continuous coat of Sika® Primer-290 DC, using a clean brush or felt applicator



Drying time: minimum 60 minutes, maximum 24 hours

Aluminium Decks (Painted)



Clean the substrate with Sika® Cleaner-205, using a clean, lint-free rag or paper towel. Change frequently!



Drying time: minimum 10 minutes, maximum 2 hours

Bronze, Brass or Stainless Steel Fittings



Clean the substrate with Sika® Cleaner-205, using a clean, lint-free rag or paper towel. Change frequently!



Drying time: minimum 10 minutes, maximum 2 hours



Apply a thin, continuous coat of Sika® Primer-210 T, using a clean brush or felt applicator.



Drying time: minimum 30 minutes, maximum 24 hours

Aluminium Fittings



Lightly abrade contact area with a very fine sanding pad (Scotch-Brite M 600).



Clean the substrate with Sika® Cleaner-205, using a clean, lint-free rag or paper towel. Change rag frequently!



Drying time: minimum 10 minutes, maximum 2 hours



Apply a thin, continuous coat of Sika® Primer-210 T, using a clean brush or felt applicator.



Drying time: minimum 30 minutes, maximum 24 hours

For the preparation of other substrates, please refer to the Primer Chart.

Application of Sikaflex®-291/292 Adhesive



Sikaflex®-291 or 292 should be applied to the deck and the fixing screw holes in a bead of the required thickness. The fitting is then pressed into position.

The fixing screws should be tightened sufficiently to pull the fitting down on the spacers, but no more. Use a plastic spatula to remove excess sealant squeezed out around the edges. After 24 hours tighten the screws.



Traces of uncured Sika adhesives or sealants may be removed with Sika® Remover-208. On no account should other cleaning agents or Sika® Cleaner-205 be used for this purpose.

Important: Please refer to the current Sika Technical Data Sheets and Safety Data Sheets obtainable through Sika or their local distributor.

Instructions for Sealing of High-UV-Risk Areas



Description of Application

On modern ships, yachts and motor boats the joints between different materials must be sealed to protect against water ingress, corrosion, etc. In addition, they must also supply an aesthetic finish to the joint. High-performance sealant joints can be made with conventional one-component, polyurethane-based systems, which, due to their excellent adhesion to various substrates, allow permanent elasticity and resistance against water ingress and corrosion. Conventional polyurethane sealants, however, exhibit some sensitivity to UV radiation. After very prolonged periods of exposure the joint surface may exhibit slight degradation. This does not detract from the sealing properties, as it is only a surface effect. If a durable surface aspect is required, the use of a specifically formulated, UV-resistant polyurethane should be considered. Most ships and particularly luxury yachts and vessels require a large number of such joints and hence require the use of a high-durability sealant. Sikaflex®-295 UV (Fig. A), in white or black, provides excellent resistance against solar UV radiation and sea water attack, the white grade also providing superior non-yellowing characteristics. Sikaflex®-295 UV is therefore particularly suited for sealing such areas as deck fittings, hatches, window rebates, etc.

Preparation of Substrate

Wood



Abrade contact area on hull with sanding pad (80/100 grit) and remove dust with a vacuum cleaner.



Apply a thin continuous coat of Sika® Primer-290 DC, using a clean brush or felt applicator



Drying time: minimum 60 minutes, maximum 24 hours

Aluminium and Stainless Steel



Clean the substrate with Sika® Cleaner-205, using a clean, lint-free rag or paper towel. Change frequently!



Drying time: minimum 10 minutes, maximum 2 hours

Acrylic and Polyurethane-Based Paint



Clean the substrate with Sika® Cleaner-205, using a clean, lint-free rag or paper towel. Change frequently!



Drying time: minimum 10 minutes, maximum 2 hours

GRP



Lightly abrade contact area with a very fine sanding pad. Remove dust with a vacuum cleaner.



Clean the substrate with Sika® Cleaner-205, using a clean, lint-free rag or paper towel. Change frequently!



Drying time: minimum 10 minutes, maximum 2 hours



Apply a thin, continuous coat of Sika® Primer-206 G+P or Sika® Primer-215, using a clean brush or felt applicator.



Drying time: minimum 30 minutes, maximum 24 hours

For the preparation of other substrates, please refer to the Primer Chart for Sika Marine Applications.



Fig. A

Application of Sikaflex®-295 UV Adhesive



Sikaflex®-295 UV should be applied to the joint in a bead of the required dimensions taking care to avoid air entrapment.

Use a plastic spatula to remove excess sealant squeezed out around the edges. Tool to a smooth finish within the tack-free time of the sealant using Sika® Tooling Agent N.



Traces of uncured Sika adhesives or sealants may be removed with Sika® Remover-208. On no account should other cleaning agents or Sika® Cleaner-205 be used for this purpose.

Important: Please refer to the current Sika Technical Data Sheets and Safety Data Sheets obtainable through Sika or their local distributor.

Note: Instructions for the use of specifically formulated, UV-resistant products such as Sikaflex®-295 UV do not apply in situations where UV radiation may directly attack the bond faces, e.g. transparent substrates. Please consult the specific instructions for these applications. Sikaflex®-295 UV is not suitable for teak deck caulking.

Instructions For Bonding of Rub Rails and Fenders



Description of Application

Rub rails and fenders are designed to protect the hull of a ship or boat against damage. They act as a bumper to absorb impacts and scrapes, and the more elastic they are, the more effectively they can perform this function.

Their elastic behaviour varies according to the type of material used. The shock-absorbing performance of the rub rail is significantly improved by the use of an elastic adhesive joint. This affords maximum protection to the hull.

Rub rails of conventional timber, PVC or polyurethane construction can be securely bonded to marine hulls using Sikaflex®-292. The resulting elastic joint helps to absorb most of the shear and tensile stresses to which rub rails are subjected when a vessel is docking or casting off.

In the case of rub rails secured with screws, a similar effect can be obtained by backfilling the rail profile with Sikaflex®-291, a highly elastic polyurethane sealant. As well as absorbing torsional stresses, this also seals the screw holes and prevents the ingress of water or dirt behind the rub rail.

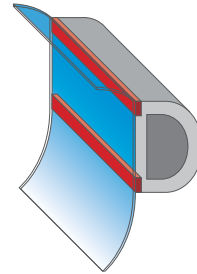

Preparation of Substrate

GRP Hulls



Heavily soiled surfaces should be cleaned off first with a pure solvent (Sika® Remover-208) to remove the worst of the soiling.



Lightly abrade contact area with a very fine sanding pad. Remove dust with a vacuum cleaner.



Clean the substrate with Sika® Cleaner-205, using a clean, lint-free rag or paper towel. Change frequently!



Drying time: minimum 10 minutes, maximum 2 hours



Apply a thin, continuous coat of Sika® Primer-206 G+P or Sika® Primer-215, using a clean brush or felt applicator.



Drying time: minimum 30 minutes, maximum 24 hours

Finished Painted Hulls of Aluminium or Steel, Coated with Two-part Lacquer



Clean the substrate with Sika® Cleaner-205, using a clean, lint-free rag or paper towel. Change frequently!



Drying time: minimum 10 minutes, maximum 2 hours

Timber Rub Rails



Abrade contact area on hull with sanding pad (80/100 grit) and remove dust with a vacuum cleaner.



Apply a thin, continuous coat of Sika® Primer-290 DC, using a clean brush or felt applicator



Drying time: minimum 60 minutes, maximum 24 hours.

Moulded PVC or Polyurethane Rub Rails



The bond face of the rub rails must be free from mould release agents or other chemical contaminants. All traces of such substances must be removed prior to proceeding.



Abrade the bond face of the rub rail with coarse sand paper (60/80grit) to key the surface.



Clean the substrate with Sika® Cleaner-205, using a clean, lint-free rag or paper towel. Change frequently!



Drying time: minimum 10 minutes, maximum 2 hours

Because of the variable composition of rub rails, an adhesion test is advised prior to installation.

Application of Sikaflex®-292/291 Adhesive/Sealant



Place elastic spacers in position (thickness 2 mm, approximately 50 Shore A hardness).



Apply Sikaflex®-292 (or Sikaflex®-291 if rub rails are to be secured using additional mechanical fixation) in an 8 mm x 10 mm triangular bead to the proposed bond area.



Assemble components within 20 minutes of applying adhesive.



Press the rub rail into place, either directly onto the face of the hull or fitted over the core profile. Use clamps, etc. to hold the rub rail in position while the adhesive sets. If the rub rail is to be secured with mechanical fixings, any holes should also be filled with adhesive.



Clamps and other fastening aids can be removed after 24 hours. Full service strength is attained after approximately 7 days.



Traces of uncured Sika adhesives or sealants may be removed with Sika® Remover-208. On no account should other cleaning agents or Sika® Cleaner-205 be used for this purpose.

Important: Please refer to the current Sika Technical Data Sheets and Safety Data Sheets obtainable through Sika or their local distributor.

Instructions For Keel-to-Hull Joints and Sealing



Description of Application

The joint between keel and hull is subjected to very high stresses, particularly when a boat is under sail or if it runs aground.

This critical joint must be designed and executed with great care to withstand these stresses.

The joint between keel and hull is particularly prone to leaks, which manifest themselves in the form of rust streaking and staining on the keel when the boat is removed from the water. The use of Sikaflex® in conjunction with the mechanical fixings prevents water penetration and improves stress distribution.



Fig. A

Important Note: The bond face on the keel and hull must also be wiped down with Sika® Cleaner-205. In the case of lead keels, the contact area must additionally be given a coat of two-part epoxy resin protective paint. Drying time: 1 day minimum.

Preparation of Substrate

Aluminium Hulls



Heavily soiled surfaces should be cleaned off first with a pure solvent (Sika® Remover-208) to remove the worst of the soiling.



Lightly abrade contact area with a very fine sanding pad. Remove dust with a vacuum cleaner.



Clean the substrate with Sika® Cleaner-205, using a clean, lint-free rag or paper towel. Change rag frequently!



Drying time: minimum 10 minutes, maximum 2 hours



Apply a thin, continuous coat of Sika® Primer-210 T, using a clean brush or felt applicator.



Drying time: minimum 30 minutes, maximum 24 hours

GRP Hulls



Heavily soiled surfaces should be cleaned off first with a pure solvent (Sika® Remover-208) to remove the worst of the soiling.



Lightly abrade contact area with a very fine sanding pad. Remove dust with a vacuum cleaner.



Clean the substrate with Sika® Cleaner-205, using a clean, lint-free

rag or paper towel. Change rag frequently!



Drying time: minimum 10 minutes, maximum 2 hours



Apply a thin, continuous coat of Sika® Primer-206 G+P or Sika® Primer-215, using a clean brush or felt applicator.



Drying time: minimum 30 minutes, maximum 24 hours

Timber Hulls



Abrade contact area on hull with sanding pad (80/100 grit) and remove dust with a vacuum cleaner.



Apply a thin, continuous coat of Sika® Primer-290 DC, using a clean brush or felt applicator



Drying time: minimum 60 minutes, maximum 24 hours

Steel Hulls, Coated with Two-part Corrosion Protection Coating



Clean the substrate with Sika® Cleaner-205, using a clean, lint-free rag or paper towel. Change rag frequently!



Drying time: minimum 10 minutes, maximum 2 hours

For the preparation of other substrates, please refer to the Primer Chart.

Application of Sikaflex®-292 Adhesive



Place elastic spacers in position (thickness 10 mm, approximately 50 Shore A hardness).



Apply Sikaflex®-292 in 20–25 mm high triangular profiles. Each bead must form a continuous, closed ring, with no gaps. The same applies to the beads around the bolt holes.



The keel is then lifted into position, observing carefully the open time of Sikaflex®-292 and pulled up on the keel bolts as far as the spacer blocks. The adhesive that is squeezed out of the joint can be tooled to a smooth finish.



After three or four days, the keel bolts can be tightened to their full torque rating. The additional pressure thereby exerted on the adhesive, gives the joint between keel and hull the required degree of torsional stiffness. When the adhesive has fully hardened, the sealed joint can be overpainted in the normal way with any good quality anti-fouling paint. The sealed joint absorbs the dynamic stresses generated in this area and forms a totally watertight bond between keel and hull.



Traces of uncured Sika adhesives or sealants may be removed with Sika® Remover-208. On no account should other cleaning agents or Sika® Cleaner-205 be used for this purpose.

Important: Please refer to the current Sika Technical Data Sheets and Safety Data Sheets obtainable through Sika or their local distributor.

Instructions for

Bonding and Sealing “Organic Glass” (Plastic) Windows



Description of Application

Most of the plastic glazing materials used in boat building are either clear acrylic sheet (PMMA), widely marketed under trade names such as “Perspex” and “Plexiglas” (the latter manufactured by Röhm and Haas), or polycarbonate (PC), marketed by Röhm and Haas as “Makrolon” and by General Electric as “Lexan”.

All plastic glazing products possess certain characteristics that must be clearly understood before these products are installed or bonded with adhesives. In general, incorrectly installed plastic glazing panels are prone to stress cracking, which may be aggravated by the use of certain adhesives.

Plastic glazing products have a higher coefficient of thermal expansion than conventional glass. Therefore, when designing glazing installations, an expansion gap of at least 5 mm (see edge sealing page 17) all round must be incorporated between the window rebate and the plastic glazing panel to accommodate thermal movement. Similarly, any clearance holes for fixing screws must be drilled oversize, i.e. larger than the actual diameter of the screw shank.

To minimise the risk of stress cracking, flat sheets of plastic glazing material should be installed

completely flat; they should not be forced to take up a curvature by the use of mechanical fastenings. When the design calls for curved glazing panels, these should be prefabricated to order and properly tempered by a specialist supplier to ensure a stress-free installation.

As many varieties of organic glass exist it is recommended to ensure that the specific grade selected is suitable for use with Sikaflex®-295 UV. For further details contact Sika.

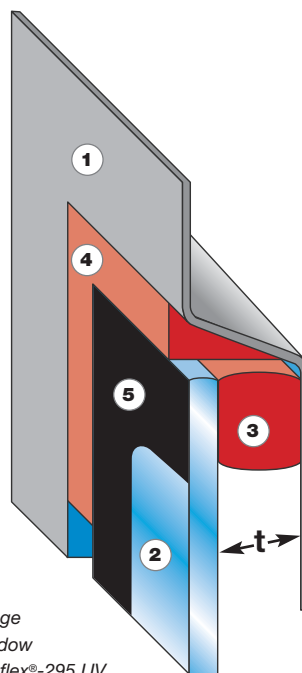
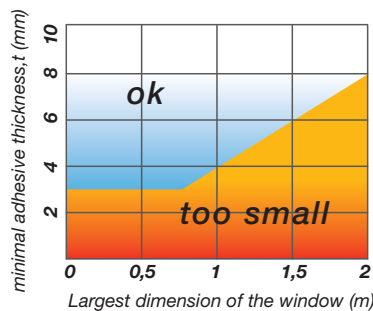

- 1 Flange
- 2 Window
- 3 Sikaflex®-295 UV
- 4 Sikaflex®-295 UV
- 5 Sika® UV Shielding Tape

Preparation of Substrate

GRP Frame



Lightly abrade contact area with a very fine sanding pad. Remove dust with a vacuum cleaner.



Clean the substrate with Sika® Cleaner-205, using a clean, lint-free rag or paper towel. Change frequently!



Drying time: minimum 10 minutes, maximum 2 hours



Apply a thin, continuous coat of Sika® Primer-206 G+P or Sika® Primer-215, using a clean brush or felt applicator.



Drying time: minimum 30 minutes, maximum 24 hours

Anodised Aluminium Frame



Lightly abrade surface with Scotch Brite M 600, clean with Sika® Cleaner-205, using a clean, lint-free rag or paper towel. Change frequently!



Drying time: minimum 10 minutes, maximum 2 hours



Apply a thin, continuous coat of Sika® Primer-210 T, using a clean brush or felt applicator.



Drying time: minimum 30 minutes, maximum 24 hours

PMMA / PC Glazing Panels



Mask off perimeter bond area with masking tape. Abrade bond area with abrasive paper or Scotch-Brite.



Clean the substrate with Sika® Cleaner-205, using a clean, lint-free rag or paper towel. Change frequently!



Drying time: minimum 10 minutes, maximum 2 hours



Apply a continuous coat of Sika® Primer-209, using a clean brush or felt applicator.



Drying time: minimum 30 minutes, maximum 24 hours

Timber or Aluminium Frame Coated with Two-Part Lacquer



Clean the substrate with Sika® Cleaner-205, using a clean, lint-free rag or paper towel. Change frequently!



Drying time: minimum 10 minutes, maximum 2 hours

Refer to Sika® primer chart for other substrates.

Instructions for

Bonding and Sealing “Organic Glass” (Plastic) Windows



Fig. B



Fig. C

Protection of the Bond

As with conventional glass, plastic glazing panels generally do not protect the adhesive face from damage by UV radiation. Therefore, the bond face must be protected from direct sunlight via one of the methods recommended.

Application of Sikaflex®-295 UV Adhesive



Place spacers in position. Depending on the size of the glazing panel, the thickness of the spacer should be chosen accordingly; approximately 30 Shore A hardness (see diagram page 16).



Apply Sikaflex®-295 UV to the frame rebate or glazing panel using a triangular nozzle of bead width 10 mm minimum.



Assemble components within 20 minutes of applying adhesive.



To prevent slip down of vertical glazing panels, additional spacers (wood or plastic) must be placed in the lower rebate during installation. After curing, these must be removed. The rebate gap must be a minimum of 5 mm (see diagram below).



Clamps and other fastening aids can be removed after 24 hours. After this time, the expansion gap between glazing panel and rebate can be filled and sealed with Sikaflex®-295 UV. This should be done only when the glazing adhesive has reached full cure. This sealant joint can be tooled to a smooth finish using Sika® Tooling Agent N. This must be carried out before skinning of the sealant.



Traces of uncured Sika adhesives or sealants may be removed with Sika® Remover-208. On no account should other cleaning agents or Sika® Cleaner-205 be used for this purpose.



Apply cover strip or Sika® UV Shielding Tape to cover the bondline in accordance with Sika recommendation.

Important: Please refer to the current Sika Technical Data Sheets and Safety Data Sheets obtainable through Sika or their local distributor.

Edge Sealing of Window

Commonly, the edge of the window will be cosmetically finished with Sikaflex® materials. The preparation of the surfaces must be identical to that used for bonding. Edge sealing both ensures the prevention of standing water on or near the bond and helps cosmetically finish the window. For plastic window panels Sikaflex®-295 UV must be used in accordance with the diagram.

- External cover strip of appropriate dimensions
- Sika® UV Shielding Tape of appropriate dimensions

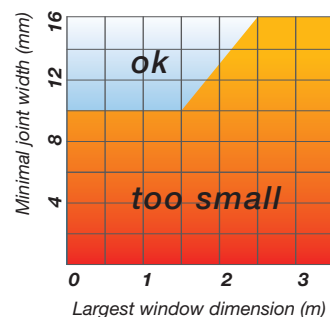
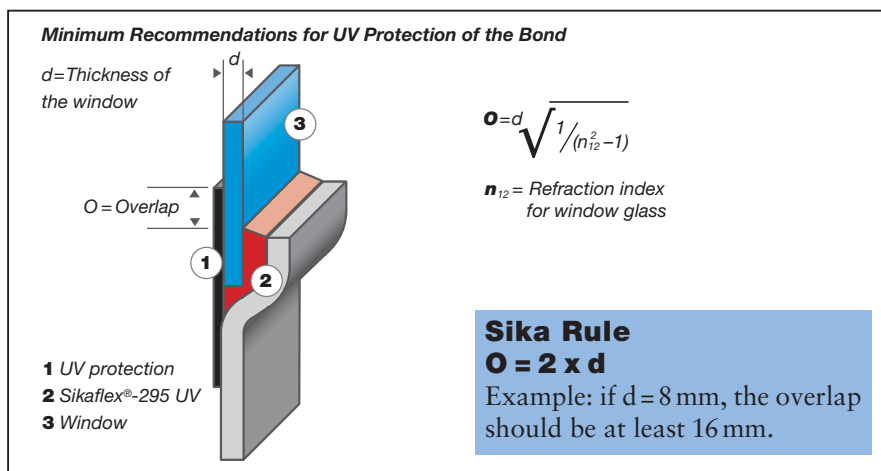

Instructions for

Bonding and Sealing Mineral Glass Windows



Description of Application

The direct glazing of mineral glass (toughened security glass) into frames or directly into the hull or deck, requires a full understanding of all the important principles involved.



It is essential that the glass meet all the demands and standards required for the intended application. For insulation glass, total bonding consistency must be ensured through the complete use of Sikaflex® adhesives for all the installation, i.e. no silicones. The polyurethane adhesive bond face must also be protected against UV radiation. This may be achieved by several means:

Using a black, ceramic coated border with a light transmission of less than 0.01% (measured with Gretag D 200 visible range). Or by using an overlapping trim (plastic or metal) with a width twice that of the glass thickness.

For glass without a black, ceramic coated border or without the overlapping trim, Sika® UV Shielding Tape should be used for proper protection of the bondline.

Dimensioning of Adhesive and Sealant

The dimensioning of the adhesive and joint geometry must be carried out in accordance with Sika's basic rules of calculation. If deck movement is negligible the following dimensions are recommended.

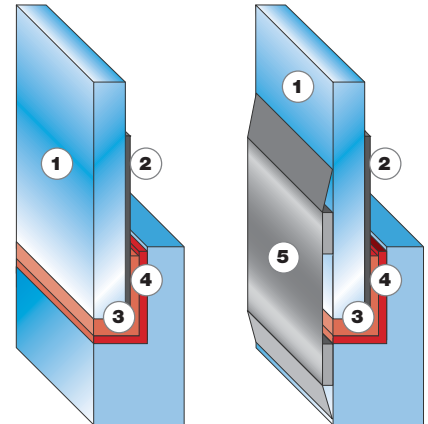

- 1 Mineral glass
 - 2 Ceramic coating
 - 3 Sikaflex®-296
 - 4 Flange
- 1 Mineral glass
 - 2 Ceramic coating
 - 3 Sikaflex®-296
 - 4 Flange
 - 5 Edge Protection

Glass Window Dimensioning
Joint width

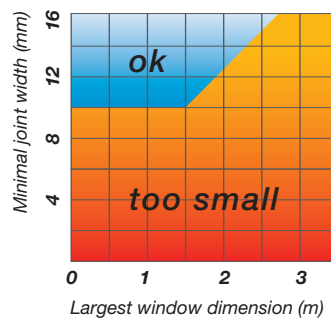

Glass Window Dimensioning
Adhesive thickness, t

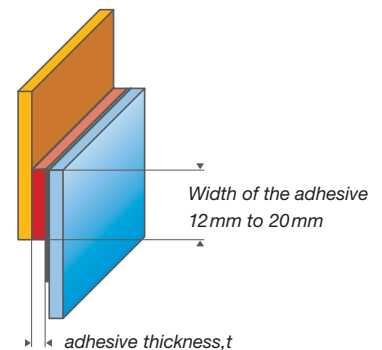
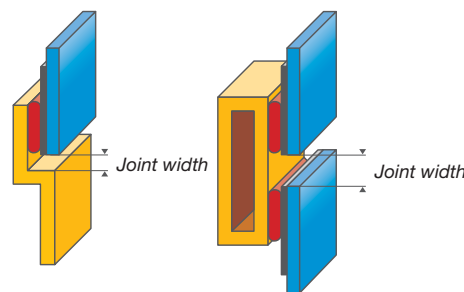
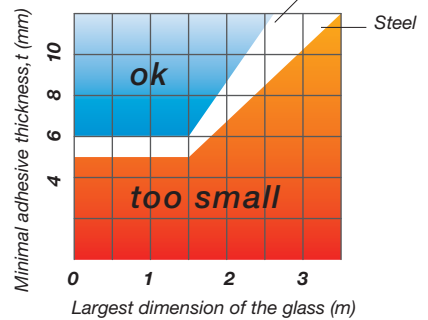

Note: Local and international rules for maritime construction and appropriate legislation must always be observed.

Instructions for Bonding and Sealing Mineral Glass Windows



Preparation of Substrate

Glass (additional UV shielding required)



Clean the substrate with Sika® Activator, using a clean, lint-free rag or paper towel. Change frequently!



Drying time: minimum 10 minutes, maximum 2 hours

Black, Ceramic Glass Border (transmission <0.01%)



Clean the substrates with Sika® Activator, using a clean, lint-free rag or paper towel. Change frequently!



Drying time: minimum 10 minutes, maximum 2 hours

For the preparation of the frame, please refer to the Primer Chart.

Protection of the Bondline

Conventional glass without a ceramic frit does not protect the adhesive face from damage by UV radiation. Therefore, the bond face must be protected from direct sunlight via one of the materials recommended below.

- External cover strip of appropriate dimensions
- Sika® UV Shielding Tape of appropriate dimensions

Application of Sikaflex®-296 Adhesive



Place spacers in position. The thickness of the spacer should be a minimum of 5 mm approximately 30 Shore A hardness (according to diagram).



Apply Sikaflex®-296 to the frame rebate or glazing panel using a triangular nozzle of bead width 10 mm minimum.



Assemble components within 20 minutes of applying adhesive.



To prevent slip down of vertical glazing panels, additional spacers (wood or plastic) must be placed in the lower rebate during installation. After curing, hard spacers must be removed. The rebate gap must be a minimum of 5 mm.

Clamps and other fastening aids can be removed after 24 hours. After this time, the expansion gap between glazing panel and rebate can be filled and sealed with Sikaflex®-296. This should be done only when the glazing adhesive has reached full cure. This sealant joint is tooled to a smooth finish using Sika® Tooling Agent N. This must be carried out before skinning of the sealant.



Traces of uncured Sika adhesives or sealants may be removed with Sika® Remover-208. On no account should other cleaning agents or Sika® Cleaner-205 be used for this purpose.



Service of the vessel can be resumed after one week.

Important: Please refer to the current Sika Technical Data Sheets and Safety Data Sheets obtainable through Sika or their local distributor.

Minimum Recommendations for UV Protection of the Bond

d = Thickness of the window

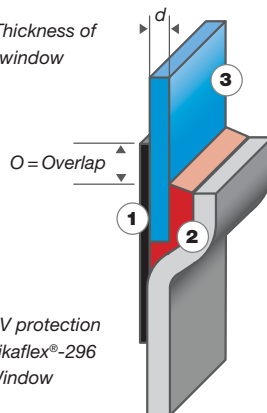

- 1 UV protection
- 2 Sikaflex®-296
- 3 Window

$$O = d \sqrt{1 / (n_{12}^2 - 1)}$$

n_{12} = Refraction index for window glass

$$O = d \times 0,9$$

Sika Rule $O = 2 \times d$

Example: if $d = 8$ mm, the overlap should be at least 16 mm.



Instructions For

Bonding of Decorative Panels and Work Surfaces



Description of Application





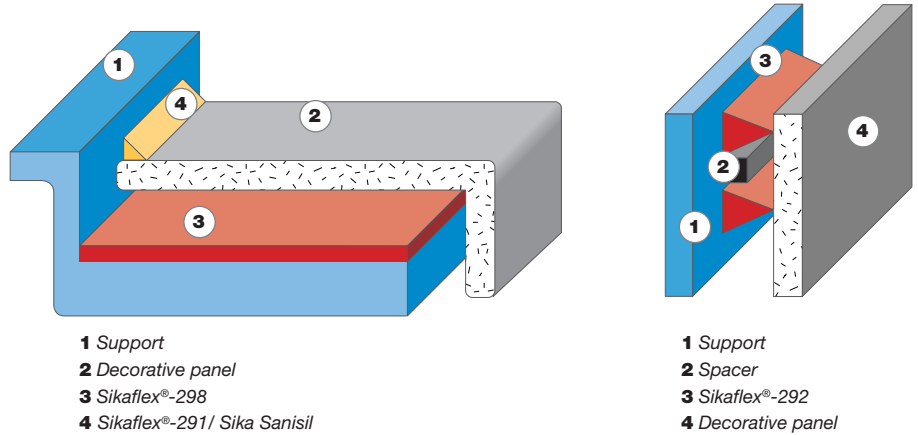

The interiors of many boats are often based on a variety of traditional and modern materials including mirrored glass, Avonite®, Corian®, etc. These panels may be used purely for cosmetic reasons or function as working surfaces (galley worktops, etc); either way, elastic bonding provides an easy, durable method of fixing without visible and unsightly mechanical fixing.

As the variety of materials used for panels, surfaces and supporting substrates is so vast, for surface preparation please consult the Sika® Primer Chart.





Application of Sikaflex® Adhesives

Vertical Panels

-  Place spacers in position (thickness typically 3 mm, approximately 50 Shore A hardness).
-  Apply parallel beads of Sikaflex®-292 at 600 mm centres in an 8 mm x 10 mm triangular bead.
-  Assemble components within 20 minutes of applying adhesive.
-  Panels, if required, may be held in place during cure by clamps, support brackets, or by the use of SikaTack®-Panel Tape.
-  Clamps and other fastening aids can be removed after 24 hours. Full service strength is attained after approximately 7 days.
-  Traces of uncured Sika adhesives or sealants may be removed with Sika® Remover-208. On no account should other cleaning agents or Sika® Cleaner-205 be used for this purpose.

Horizontal Panels

-  Flat surfaces: Sikaflex®-298. Inclined surfaces: Sikaflex®-291
Apply adhesive to previously prepared surface and spread over area to be covered, using a spreader with 4 mm triangular notches. The bed thickness may vary depending on the thickness of any gap that needs to be filled (normally 1–2 mm)
-  The panel must be positioned accurately within the tack free time of the adhesive and pressed firmly into place to avoid air-entrapment.
-  Clamps, weights or screws (removable once the adhesive has set) can be used to secure the panel while the adhesive sets. Alternatively, the vacuum press method may be used. After approx. 24 hours the panels can carry their full service load and the temporary fastenings can be removed. In case vapour-tight substrates are employed, spray a fine mist (ca. 10 g/m²) onto the Sikaflex®-298 surface to ensure fast curing.

Important: Please refer to the current Sika Technical Data Sheets and Safety Data Sheets obtainable through Sika or their local distributor.

Note: Exposed seals in wet work areas may require a mildew resistant sealant such as Sika Sanisil. Contact Sika for further information.



General

Substrates should be free from dust, dirt, oil, grease and any contaminants. Any dirty, corroded or degraded areas of the joint must be cleaned.

Paintability

Most of the common paints (except alkyd-based paints) can be used on top of Sikaflex® products. The best results are obtained when the adhesive/sealant is fully cured. It is, however, recommended that the compatibility is checked by pretesting if early painting is required or in critical applications. Please note that rigid paint systems prevent joint movement, which may lead to cracking of the paint and defects in the seal.

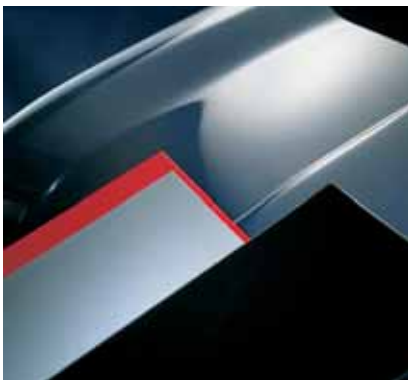

Coated Surfaces, Paints and Varnishes

Pretesting of adhesion is a prerequisite on coated surfaces. As a guide, reactive systems which are cross-linked thermally (powder coatings) or by polyaddition reaction (epoxy or PUR coatings) can be bonded with Sikaflex® products. Alkyd resin-based paints/varnishes which dry by

oxidation are less suitable.

Polyvinylbutyral, epoxy resin ester systems and other non-reactive air-drying one-component paints are lower in final strength and are generally compatible, physically, with our sealants; however, depending on stresses, may or may not be strong enough for use with our adhesives. Please note that paint additives which act on the surface of the paint or varnish, such as coalescing agents, silicones, anti-foams, etc. can effect the adhesion of the adhesive/sealant to the paint and should be removed from the surface.

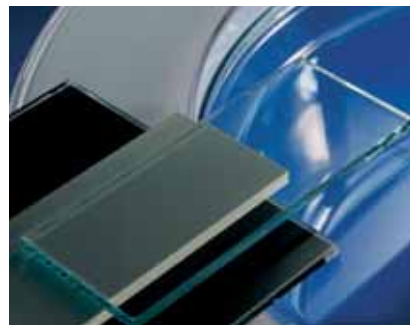

Glass and Other Transparent Substrates

If a transparent substrate is used where the bond is exposed to direct sunlight through the transparent layer, additional protection against UV radiation is required.

This could be:

- a mechanical protection like a trim or metallic profile,
- a ceramic screen-printed peripheric edge (onto mineral glass) providing a sufficient barrier against UV radiation, or

- a black or white coloured film such as Sika® UV Shielding Tape.

Under all circumstances the overlap of any of the aforementioned variants should be taken into consideration because of refractive effects.

If in doubt it is recommended to consult with Sika.

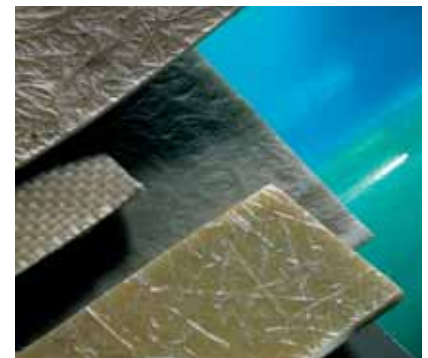

Glassfibre Reinforced Plastic (GRP)

Generally, GRP's represent a thermosetting plastic of unsaturated polyester resin (UP), an epoxy resin (EP) or a polyurethane resin (PUR). Sometimes freshly produced UP-GRP parts may still contain residual styrene monomer, and, since the chemical reaction is not completed, subsequently show post-shrinkage. Only postcured or aged GRP parts should be bonded. The smooth side (gel-coated side) of the GRP part may contain mould release agents. These impair the subsequent bonding capabilities to the surface and should be removed. The rough side of the GRP panels generally

Notes on Substrates (continued)

contain paraffin waxes as an air-drying additive. If bonding needs to take place to this side the panel needs careful abrasion, cleaning with Sika® Cleaner-205 and priming with Sika® Primer-206 G+P or Sika® Primer-215. Thin, transparent or only lightly coloured GRP parts are UV-permeable (see the section under transparent substrates).

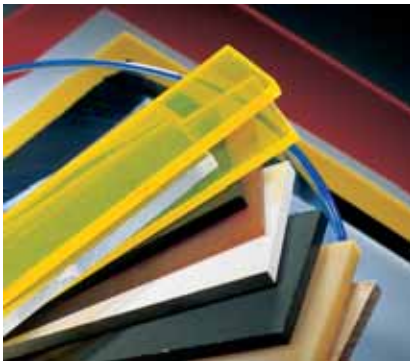

Plastics

Some plastic materials can only be bonded with mechanical/chemical treatments (flaming, plasma, chemical oxidation), e.g. polyethylene and polypropylene. As it is not possible to supply clear recommendations for bonding of many plastic compounds, because of the many different mix constituents and internal and external release agents, it is recommended to contact Sika. Checks can be made on the materials to determine the proper preparation suitable for your purposes and we can therefore advise you accordingly.

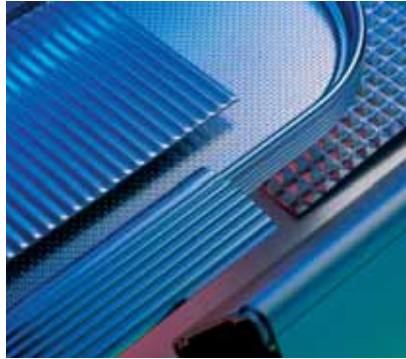

Aluminium

Aluminium and its alloys are supplied in sections, sheets, panels, profiles, and castings. The preparation instructions depend on which Sikaflex® product is involved. For surface-treated aluminium (chrome-plated, anodised or coated) cleaning with Sika® Cleaner-205 is often the only preparation needed before bonding.



Galvanised Steel

Galvanised steel is either:

- hot galvanised (strip galvanised),
- electrolytically galvanised,
- hot galvanised (hot dip).

For the first two substrates the base is clearly defined and the surface composition is mostly constant, whereas the surface finish of the third is not constant and the adhesion properties need checking periodically. We strongly recommend pretesting.

Sikaflex® Marine Adhesives and Sealants



Product	Sikaflex®-290 DC	Sikaflex®-291	Sikaflex®-292	Sikaflex®-295 UV	Sikaflex®-296	Sikaflex®-298	Sikaflex®-852FR
Description	Deck caulking compound	Marine sealing compound	Strong elastic adhesive for marine applications	Fast-curing direct-glazing adhesive	High strength direct glazing adhesive	Spreadable adhesive for marine applications	Sealing and adhesive system
Uses	Sealing joints in timber deck planking	General purpose sealing and bonding	Structural bonding	Bonding of organic glass. UV resistant sealing	Bonding mineral glass	Bonding of decks panels and sheets	Sealing/bonding where Flame retardancy is required
Chemical base	1-part polyurethane	1-part polyurethane	1-part polyurethane	1-part polyurethane	1-part polyurethane	1-part polyurethane	1-part polyurethane
Stability (nonsag rating)	Thixotropic	Good	Very good	Good	Very good, with no tendency to sag or slump	Fluid	Good
Tack free time 23°C, 50% R.H.	60 minutes approx.	60 minutes approx.	40 minutes approx.	50 minutes approx.	45 minutes approx.	60 minutes approx.	60-90 minutes
Rate of cure	3 mm per 24 hrs.	3 mm per 24 hrs.	4 mm per 24 hrs.	3 mm per 24 hrs.	>3.5mm per 24 hrs.	3 mm per 24 hrs.	3 mm per 24 hrs.
Shore A hardness (DIN 53505) at 23°C	35 approx.	40 approx.	55 approx.	35 approx.	45 approx.	35 approx.	50 approx.
Elongation at break (DIN 53504)	> 250%	> 400%	>300%	> 500%	> 450%	> 600%	> 300%
Tensile strength (DIN 53504)	1,3 N/mm ² approx.	1,8 N/mm ² approx.	4 N/mm ² approx.	3 N/mm ² approx.	> 6,5 N/mm ² approx.	1 N/mm ² approx.	2,5 N/mm ² approx.
Application temperature range	+5°C to +25°C	+10°C to +35°C	+10°C to +35°C	+10°C to +35°C	+10°C to +35°C	+10°C to +35°C	+10°C to +35°C
Service temperature range	-40°C to +90°C	-40°C to +90°C 120°C (short exposure)	-40°C to +90°C 120°C (short exposure)	-40°C to +90°C 140°C (short exposure)	-40°C to +90°C 120°C (short exposure)	-50°C to +80°C 100°C (short exposure)	-40°C to +90°C 120°C (short exposure)

Important: Please refer also to the current Sika Technical Data Sheets and Safety Data Sheets obtainable through Sika or their local Distributor

Cleaner, Primer and Adhesive Consumption Table

Product	Packaging Unit in ml	Quantity per m ² required in ml	Coverage/ Unit in m ²	Length of primed surface 30 mm wide in metres
Sika® Activator	250	40	6.25	
Sika® Cleaner-205	250 1000	40	6.25 25.00	
Sika® Primer-206 G+P	30 250	150	0.20 1.60	6 50
Sika® Primer-209	250	150	1.60	50
Sika® Primer-210 T	250 1000	150	1.60 6.60	50 200
Sika® Primer-215	250 1000	150	1.60 6.60	50 200
Sika® Primer-290 DC	30 250 1000	150	0.20 1.60 6.60	6 50 200
Sika® Primer-204 N	250	150	1.60	50

Sikaflex®-290 DC Joint dimension	Coverage per unit (lineal metres)	
	310 ml	600 ml
5 x 5mm	12	24
8 x 5 mm	8	15
10 x 5 mm	6	12
10 x 7.5 mm	4	8

Contact Sika® for details on Sika® Primer-204 EP and Icosit® EG.

Thickness of Sikaflex®-298 in mm	Quantity required in l/m ²	Coverage 600 ml unit/m ²
2	2	3
4	4	6

Primer Chart for Sika Marine Applications (see page 26 for key to abbreviations)



Sealant & Adhesive	Aluminium (AlMg3)	Aluminium (AlMgSi)	Anodised Aluminium	Steel St37	Stainless Steel	Hot dipped galvanised steel
Sikaflex®-291	205	205	205	205>204EP	205	205>206GP
Sikaflex®-292	SB>205>210T SB>205>206GP SB>205>204N	SB>205>210T SB>205>206GP SB>205>204N	205>210T SB>205>206GP	SB>208>204EP SB>205>204N SB>205>206GP	SB>205>206GP	SB>205>210T SB>205>204EP SB>205>204N
Sikaflex®-296	SB>SA>210T SB>SA>206GP	SB>SA>210T SB>SA>206GP	SA>206GP 205>206GP	SB>205>206GP SB>208>204EP	SB>SA>206GP SB>205>206GP	SB>SA>206GP SB>205>206GP
Sikaflex®-295 UV	SB>205>210T SB>205>206GP	SB>205>210T SB>205>206GP	205>210T 205>206GP	SB>208>204EP SB>205>206GP	SB>205>206GP SB>205>210T	SB>205>210T SB>205>206GP
Sikaflex®-852 FR	208>204EP	208>204EP	208>204EP	208>204EP	208>204EP	208>204EP
Sikaflex®-298	EG1	EG1	205	EG1	205	EG1

Sealant & Adhesive	Electro Galvanised Steel	Glass Reinforced Polyester	ABS	Glass	Ceramic Fritted Glass	Acrylic PU Paints	Wood
Sikaflex®-291	205>206GP	S80>205>206GP S80>205>215	205>215 205>209	SA SA>206GP	SA SA>206GP	205 208	290DC Primer
Sikaflex®-292	SB>205>210T SB>205>204EP SB>205>204N	SB>205>206GP SB>205>215	SB>205>215	N.A.	N.A.	208>209	290DC Primer
Sikaflex®-296	SB>SA>206GP SB>205>206GP	SB>205>215 SB>205>206GP	SB>205>215	SA	SA	SA	290DC Primer
Sikaflex®-295 UV	SB>205>210T SB>205>206GP	SB>205>215 SB>205>206GP	SB>205>215	N.A.	N.A.	208>209	290DC Primer
Sikaflex®-852 FR	208>204EP	S80>204EP	205>215	N.A.	N.A.	TS	N.A.
Sikaflex®-298	EG1	S80>205	N.A.	N.A.	N.A.	205	290DC Primer

Primer Chart for Sika Marine Applications (key)



Abbreviation	Product/Explanation	Components	Consumption	Drying Time (23/50%)	Colour Coding (Cap)
204N	Sika® Primer-204N	I Part	0.1–0.15 kg/m ²	60 min. to 24 hours	Light Blue
205	Sika® Cleaner-205	I Part	0.04 kg/m ²	10 min. to 2 hours	Yellow
206GP	Sika® Primer-206 G+P	I Part	0.1–0.15 kg/m ²	30 min. to 24 hours	Black
208	Sika® Remover-208	I Part	0.04 kg/m ²	30 min. to 24 hours	Red
209	Sika® Primer-209	I Part	0.15–0.2 kg/m ²	30 min. to 24 hours	Green
210T	Sika® Primer-210 T	I Part	0.15–0.2 kg/m ²	30 min. to 24 hours	Grey
290DC	Sika® Primer-290 DC	I Part	0.15–0.2 kg/m ²	60 min. to 24 hours	Royal Blue
SA	Sika® Activator	I Part	0.04 kg/m ²	10 min. to 24 hours	Orange
204EP	Sika® Primer-204 EP	2 Part	0.8 kg/m ²	24 hours to 14 days	None
215	Sika® Primer-215	I Part	0.15–0.2 kg/m ²	30 min. to 24 hours	Dark Blue
EG1	Icosit® EG1 Primer	2 Part	0.2 kg/m ²	12 hours to 16 hours	None
SB	Scotch-Brite M600				
TS	Consult Technical Service				
S80	Sand paper (80 grit)				
N.A.	not applicable				
>	next step				

Worldwide Sika bonds the finest craft



Leading manufacturers in the marine industry were quick to appreciate the unique properties and quality of our innovative marine products years ago – and have been using them worldwide ever since.

Sika pioneered the development of a variety of one-component polyurethanes for marine use. They all share certain characteristics including excellent gap-filling capability and permanent elasticity. They are also sandable, non-corrosive and can be overpainted.

From the smallest boats to the largest ships, Sika provides the watertight solution.



INDUSTRY

Bonding technology with global experience



INDUSTRY

Sika Limited

Watchmead, Welwyn Garden City,
Hertfordshire AL7 1BQ
Tel: 01707 394444 Fax: 01707 329129
e-mail: sika@uk.sika.com

Sika Ireland Limited

Unit 3 Ballymun Industrial Estate,
Dublin 11, Ireland
Tel: (01) 8620709 Fax: (01) 8620707
e-mail: info@sika.ie

Website: www.sika.co.uk

